

PRODUCT GUIDE

wausauPAPER®
an SCA company

CONTENTS

Total Facility Solutions	2
Industry Innovation	4
Towel and Tissue Products	
■ Artisan®	8
■ DublSoft®	10
■ DublNature®	12
■ EcoSoft®	16
■ Dubl-Tough®	22
■ SIRRUS® Household Roll Towel	22
■ Dari-Towls®	23
Controlled Towel Dispensing Systems	
■ Alliance®	26
■ Wave'n Dry®	28
■ OptiServ Hybrid®	28
■ OptiServ®	29
■ OptiServ Accent®	29
■ Controlled Roll Towels: Specifications	30
■ Hand Hygiene: Paper Towels vs. Air Dryers	31
■ Controlled Roll Towel Dispensing Systems	32
Universal Towel Dispensers	32

Controlled Bath Tissue Dispensing Systems

■ DublServ® HC	37
■ Revolution®	38
■ DublServ® Vertical	38
■ DublServ® Side-by-Side	39
■ OptiCore® Adapter	39
■ OptiCore® Bath Tissue: Specifications	40

Universal Bath Tissue Dispensers

41

Hand Care Systems

■ OptiSource Convertible® Soap Products	44
■ Silhouette® Hand Care Product	44
■ OptiSource Convertible® Dispensing System	45

ADA Guidelines

46

Index by Catalog Number

48

Total Facility Solutions By Wausau Paper®

Wausau Paper offers a comprehensive line of premium and green products certified by Green Seal™ as well as complementary controlled-use dispensing systems for the away-from-home market. We offer unique brands of towel and tissue products: Artisan®, DublSoft®, DublNature® and EcoSoft®. Each brand, with its own unique attributes and benefits, offers customers high-quality products with exceptional performance.



The **Green Seal®** means that our products meet the most stringent and comprehensive environmental standard in our industry. In 2003, Wausau Paper became the first manufacturer to offer a complete line of towel and tissue products certified by Green Seal. Today, we have the most extensive line of Green Seal™-certified towel, tissue and soap products available in the away-from-home market.



Paper products with this logo meet Green Seal™ Standard GS-1 based on chlorine-free processing, energy and water efficiency, and content of 100% recovered material with a minimum of 50% post-consumer material for towels, 25% post-consumer material for bath tissue, and 15% post-consumer material for facial tissue. Hand care products with this logo meet Green Seal™ Standard GS-41A based on effective performance and protective limits on VOCs and human & environmental toxicity. GreenSeal.org.



Controlled Roll Towel Systems

Wausau Paper controlled roll towel systems with pre-measured dispensing control costs and waste by reducing towel consumption up to 20% over uncontrolled roll towels.



Controlled Bath Tissue Systems

OptiCore® technology, combined with our Revolution® and DublServ® dispensing systems, ensures maximum use of each roll in the dispenser before advancing to the next roll. This controlled use reduces product waste and cost.



Controlled Hand Care Systems

Wausau Paper provides hand care systems that dispense foam or lotion soaps. The OptiSource Convertible® system is available in both electronic and manual configurations, meeting any facility's budget and needs.

GREEN SEAL STANDARDS FOR TOWEL AND TISSUE (GS-1)

- 100% Recycled (recovered after papermaking process) – may also contain a mix of agricultural plant residue
- Minimum 50% post-consumer wastepaper content for paper towels (exceeds EPA minimum guidelines)
- Minimum 25% post-consumer wastepaper content in bath tissue and toilet seat covers; 15% facial tissue (exceeds EPA minimum guidelines)
- Product performance is consistently measured under controlled and reproducible laboratory conditions and products meet the requirements in the standard with respect to basis weight, tensile strength, stretch, and absorbency
- Hardwound 1-ply roll towel contains a minimum of 133 square feet of product per roll; 58 square feet per roll minimum for 2-ply kitchen roll towels
- Folded 1-ply paper towel contains a minimum of 84 square feet per package
- 2-ply bath tissue contains a minimum of 41 square feet of product per roll and facial tissue contains a minimum of 37 square feet per package
- The papermaking process, including deinking and/or bleaching, for producing paper towels and tissue is processed chlorine free (PCF) and does not contain any additives or contaminants that are carcinogens, mutagens or reproductive toxins
- The papermaking process meets the established limits for water disinfection and optical brighteners
- Papermaking additives are readily biodegradable, except for those noted in the standard
- Paper towels or bath tissue do not contain any added chlorophenolic biocides, fragrances, heavy metals, or ozone-depleting compounds
- Products are manufactured by companies that adhere to social responsibility guidelines and provide fair conditions of employment
- Products are manufactured within established annual water and energy use criteria
- The cores in the roll towels and bath tissue and the facial tissue boxes are made from 100% recycled materials
- Outer corrugated cardboard packaging is recyclable and made from at least 30% recovered material
- Packaging made from plastic is recyclable, or source-reduced by 20% or contains 25% recovered material content
- Packaging does not contain heavy metals, including lead, mercury, cadmium, and hexavalent chromium nor phthalates, bisphenol A, and chlorinated packaging material (for plastic packaging) that have intentionally been introduced
- Printing colorants on packaging do not contain lead, mercury, cadmium, and hexavalent chromium in excess of 100 parts per million (above trace levels)

Industry Innovation By Wausau Paper®

Wausau Paper leverages its expertise in green products with ATMOS papermaking technology to create unique product solutions for the away-from-home industry. This flexible papermaking process utilizes carefully chosen structured fabrics to produce premium Green Seal™-certified products designed for enhanced performance and appearance. This allows Wausau Paper to offer green towel and tissue products with exceptional plushness, brightness, strength and absorbency.

Structured for Sustainability and Quality

Wausau Paper chose to align with a technology that produces high-quality towel and tissue products while supporting sustainability. Allowing the use of 100% recycled fibers, ATMOS is environmentally superior to alternative papermaking technologies including Through-Air-Dried (TAD). With Wausau Paper's molding fabrics, paper products are also plush, soft, highly absorbent, and best of all, Green Seal™-certified.

Fashionably Formed

Wausau Paper offers DublNature® and Artisan® roll and folded towel products made with innovative ATMOS technology. This process provides premium toweling with exceptional plushness, softness and brightness. Featuring a unique weave pattern for a premium look and feel, DublNature® and Artisan® towels marry both feel and function to satisfy the most discerning customers.

Authentically Green®

All Wausau Paper products designed with ATMOS are certified as environmentally preferable by Green Seal, meeting comprehensive and strict guidelines for manufacture. Only Wausau Paper combines innovative papermaking and the finest quality fibers with the leading green certification to provide the most sustainable solution in premium paper products.

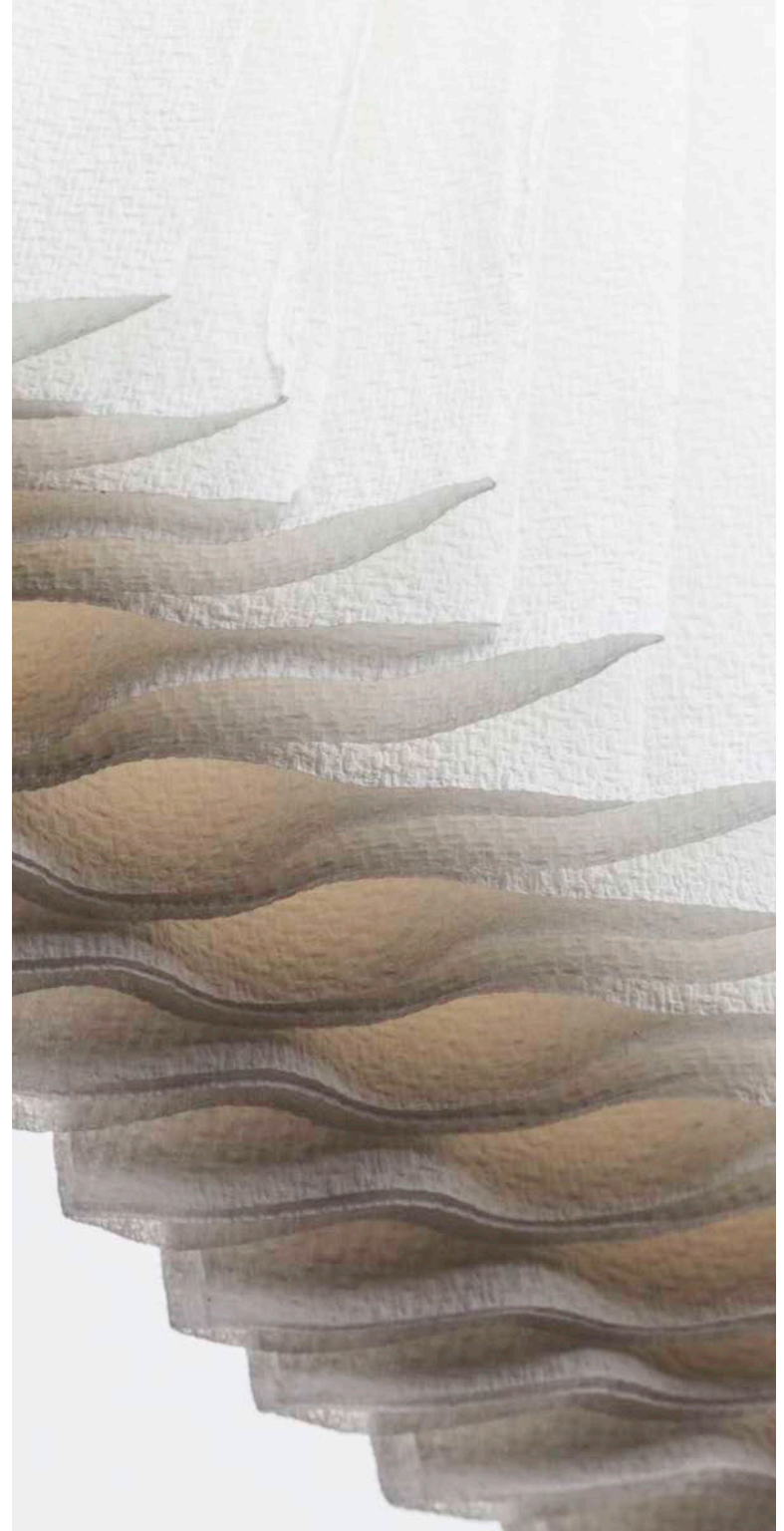



Artisan[®]

DublSoft[®]

 **DublNature**[®]

EcoSoft[®]

**TOWEL
AND
TISSUE**

Artisan®

Premium Towel Products Certified by Green Seal™



Artisan® Premium Towels

Artisan® offers superior sophistication for your hand drying experience. Carefully crafted from innovative ATMOS papermaking technology, toweling is brilliant white, remarkably strong, yet soft enough to provide a comforting hand drying experience. Artisan® caters to upscale properties such as Class A office buildings, high-end lodging establishments, and healthcare facilities. Artisan® possesses Green Seal™ certification along with luxury that is authentically designed for the refined.

Artisan® Premium Roll Towels

Superior quality Artisan® roll towels are designed for a premium hand drying experience. Toweling is brilliant white for a clean, hygienic appearance. Artisan® cloth-like towels appeal to facilities that seek exceptional quality products that reinforce an upscale image. When coupled with Wausau Paper® controlled-use dispensing systems, Artisan® towels save money by reducing waste and maintenance costs. Roll towels are available in 600 feet.

Artisan® Premium Folded Towels



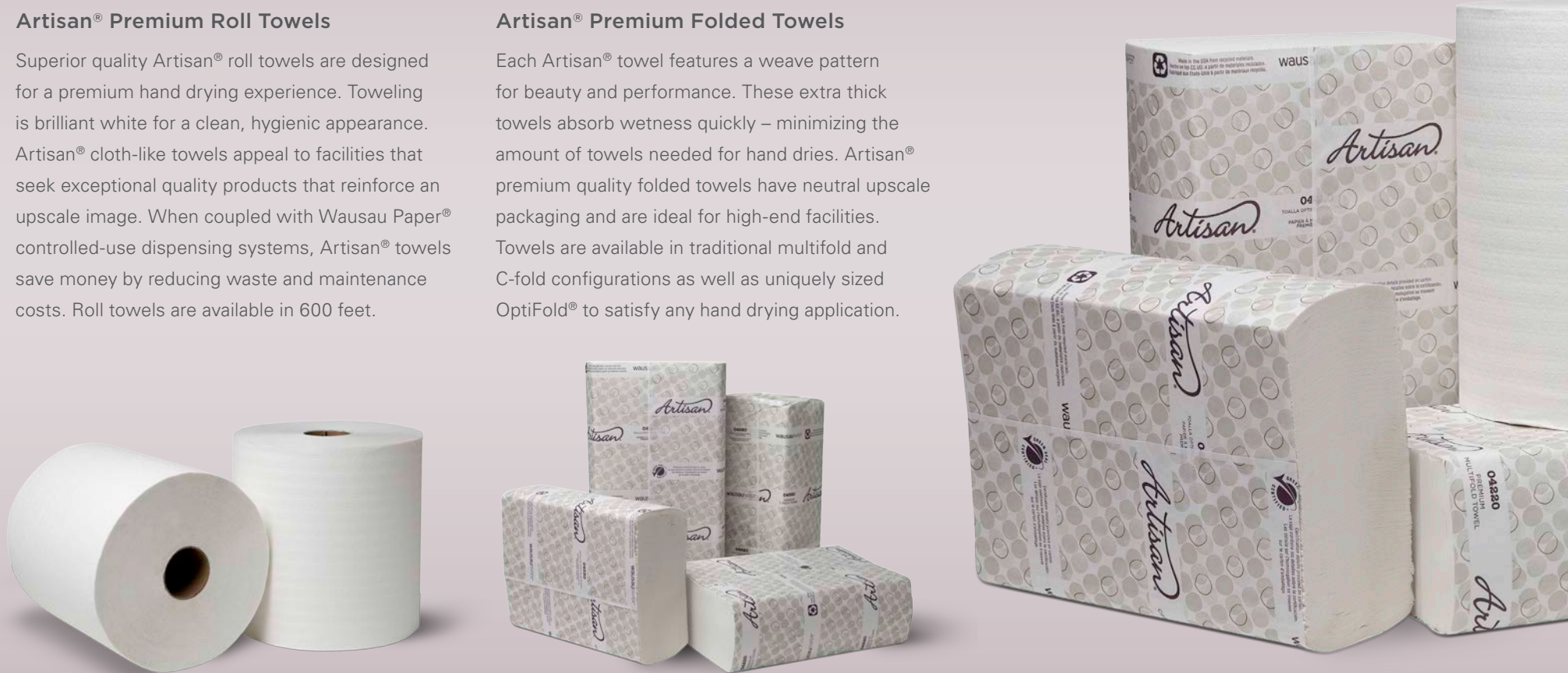

Each Artisan® towel features a weave pattern for beauty and performance. These extra thick towels absorb wetness quickly – minimizing the amount of towels needed for hand dries. Artisan® premium quality folded towels have neutral upscale packaging and are ideal for high-end facilities. Towels are available in traditional multifold and C-fold configurations as well as uniquely sized OptiFold® to satisfy any hand drying application.



Controlled Roll Towels

No.		Name	Color	Dispenser	Roll Width	Feet/Roll	Rolls/Case	Feet/Case	Cases/Unit	Cases/ Even Layer	Average Case Cube
30620		Artisan®	White	89000, 80010, 87510, 86800	8"	600	6	3,600	55	5	1.93

Folded Towels

No.		Name	Color	Dispenser	Sheet Size (W" x L")	Towels/Package	Packages/Case	Towels/Case	Cases/Unit	Cases/ Even Layer	Average Case Cube
04220		Artisan® Multifold	White	53200, 53500	9¼ x 9½	250	12	3,000	70	7	1.48
04820		Artisan® C-Fold	White	53200, 53500	10½ x 13	150	16	2,400	48	6	1.88
04420		Artisan® OptiFold®	White	53200, 53500	10¼ x 9½	250	12	3,000	56	7	1.69
04620		Artisan® OptiFold® ES	White	53200, 53500, 53800	8 x 9½	250	12	3,000	66	6	1.31

DublSoft®

Premium Tissue Products

DublSoft® Premium Bath Tissue

DublSoft® bath tissue features consumer-like floral embossing for exceptional softness. Universal tissue is available in 500 sheet count and a 400 sheet count to satisfy any facility's need. The OptiCore® tissue provides optimum savings in maintenance time and costs when combined with our OptiCore® dispensing systems.



DublSoft® Premium Facial Tissue

DublSoft® facial tissue offers superior softness for the most discriminating customers. Facial tissue features a blue food grade dye line to notify that product is low, thereby saving maintenance time. The stylish contemporary packaging makes the flat or cubed box facial an attractive addition to any décor.



Controlled Bath Tissue

No.	Name	Ply	Emboss	Dispenser	Sheet Size (W" x L")	Sheets/Roll	Rolls/Case	Sheets/Case	Cases/Unit	Cases/ Even Layer	Average Case Cube
06390	DublSoft® OptiCore®	Double	Floral	80200, 80300, 82300	3¾ x 4	800	36	28,800	48	6	2.74
06290	DublSoft® OptiCore® RC	Double	Floral	19800	3¾ x 3¾	800	36	28,800	48	6	2.05
06325	DublSoft®	Double	Pebble	72300, 88400	3¾ x 4	625	48	30,000	36	6	2.51

Universal Bath Tissue

No.	Name	Ply	Emboss	Dispenser	Sheet Size (W" x L")	Sheets/Roll	Rolls/Case	Sheets/Case	Cases/Unit	Cases/ Even Layer	Average Case Cube
06348	DublSoft®	Double	Floral	72200	4¾ x 4	500	48	24,000	45	9	2.58
06380	DublSoft®	Double	Floral	72200	4¾ x 4	500	80	40,000	20	4	3.99
06480	DublSoft®	Double	Floral	72200	4¾ x 4	400	80	32,000	20	4	3.99

Facial Tissue

No.	Name	Ply	Box	Sheet Size (W" x L")	Sheets/Box	Boxes/Case	Sheets/Case	Cases/Unit	Cases/ Even Layer	Average Case Cube
06100	DublSoft® Flat	Double	Flat	8 x 8	100	30	3,000	56	8	1.47
06185	DublSoft® Cube	Double	Cube	8 x 8	85	36	3,060	42	6	2.31

DublNature®

High-Quality Paper Products Certified by Green Seal™



DublNature® Towels and Tissue

DublNature® products are manufactured with ATMOS technology and designed for comfort and functionality. DublNature® provides versatility and is ideal for office buildings, lodging establishments, healthcare facilities, restaurants, and colleges/universities. Offering the best in quality without sacrificing green sensibilities, DublNature® offers a premium Green Seal™ experience.

DublNature® Roll Towels

DublNature® roll towels offer the softness and strength needed to elevate your hand-drying experience. DublNature® features a unique weave pattern creating highly absorbent towels so fewer are needed per hand dry. And with such exceptional brightness, you'll hardly believe DublNature® roll towels are made from 100% recycled fibers and Green Seal™-certified. Towels are available in lengths of 450', 800' and 1,000' with controlled and universal options.



DublNature® Folded Towels

DublNature® folded towels are designed for performance and offer superior strength, absorbency and softness. Folded towels are made from high-class 100% recycled fibers and contain a minimum of 50% post-consumer waste. Available in multifold, C-fold and OptiFold® configurations, there is a DublNature® folded towel that meets any facility's need.







DublNature® Bath and Facial Tissue



DublNature® tissue is Green Seal™-certified with upscale packaging to promote a premium green image. Offering the beauty of consumer bath tissue, DublNature® features attractive floral embossing. Controlled-use and universal bath tissue is designed to provide exceptional plushness and softness. Cube or flat box facial tissue has an aesthetically pleasing design that complements any décor. DublNature® bath and facial tissue are ideal for establishments seeking a premium green image.





Controlled Roll Towels

No.		Name	Color	Dispenser	Roll Width	Feet/Roll	Rolls/Case	Feet/Case	Cases/Unit	Cases/ Even Layer	Average Case Cube
31040		DublNature®	White	89000, 80010, 87510, 86800	8"	1,000	6	6,000	55	5	1.91
38040		DublNature®	White	89000, 80010, 87510, 86800	8"	800	6	4,800	55	5	1.91
34540		DublNature®	White	86600, 80010, 87510, 86800	8"	450	12	5,400	48	8	2.13

Universal Roll Towels

No.		Name	Color	Dispenser	Roll Width	Feet/Roll	Rolls/Case	Feet/Case	Cases/Unit	Cases/ Even Layer	Average Case Cube
44040		DublNature®	White	16000	8"	1,000	6	6,000	55	5	1.91
44840		DublNature®	White	16000	8"	800	6	4,800	55	5	1.91

Folded Towels



No.		Name	Color	Dispenser	Sheet Size (W" x L")	Towels/Package	Packages/Case	Towels/Case	Cases/Unit	Cases/ Even Layer	Average Case Cube
48140		DublNature® Multifold	White	53200, 53500	9½ x 9½	250	16	4,000	60	6	1.89
49140		DublNature® C-Fold	White	53200, 53500	10½ x 13	150	16	2,400	48	6	1.88
48440		DublNature® OptiFold®	White	53200, 53500	10¼ x 9½	250	12	3,000	56	7	1.61
48640		DublNature® OptiFold® ES	White	53200, 53500, 53800	8 x 9½	250	12	3,000	66	6	1.24

DubINature®



Controlled Bath Tissue

No.	Name	Ply	Emboss	Dispenser	Sheet Size (W" x L")	Sheets/Roll	Rolls/Case	Sheets/Case	Cases/Unit	Cases/Even Layer	Average Case Cube
62090	 DubINature® OptiCore®	Double	Floral	80200, 80300, 82300	3¾ x 4	865	36	31,140	48	6	2.74

Universal Bath Tissue

No.	Name	Ply	Emboss	Dispenser	Sheet Size (W" x L")	Sheets/Roll	Rolls/Case	Sheets/Case	Cases/Unit	Cases/Even Layer	Average Case Cube
59490	 DubINature®	Double	Floral	72200	4 x 3¾	500	48	24,000	45	9	2.37
59890	 DubINature®	Double	Floral	72200	4 x 3¾	500	80	40,000	30	6	3.91

Facial Tissue

No.	Name	Ply	Box	Sheet Size (W" x L")	Sheets/Box	Boxes/Case	Sheets/Case	Cases/Unit	Cases/Even Layer	Average Case Cube
08540	 DubINature®	Double	Cube	8 x 8	85	36	3,060	42	6	2.31
10040	 DubINature®	Double	Flat	8 x 8	100	30	3,000	56	8	1.47



EcoSoft®

100% Recycled and Green Seal™-certified Paper Products



EcoSoft® Roll Towels

EcoSoft® roll towels satisfy those who prefer to purchase quality towels produced with methods less harmful to the environment. These roll towels are 100% recycled, meet or exceed EPA guidelines for post-consumer wastepaper content, and many are Green Seal™-certified. Available in white, natural white and natural, EcoSoft® roll towels provide waste reduction and cost savings benefits.

EcoSoft® Folded Towels

EcoSoft® folded towels are 100% recycled and available in singlefold, multifold and C-fold configurations. Most folded towels are certified as environmentally preferable by Green Seal, Inc. of Washington, DC.

EcoSoft® Bath Tissue

Embossed for softness, EcoSoft® tissue provides the quality users expect. EcoSoft® tissue is offered in single and double ply and designed for use with our controlled-use, universal, and jumbo dispensing systems. Available in 100% recycled and Green Seal™-certified options.

EcoSoft® Facial Tissue

EcoSoft® facial tissue is soft, made of 100% recycled fiber and meets or exceeds EPA guidelines for post-consumer wastepaper content. Facial tissue offers the feel of household tissue with attractive, environmentally preferable packaging.

EcoSoft® Household Roll Towels







EcoSoft® household roll towels feature a quilted diamond emboss for superior absorbency and performance with the wet strength needed for use in business and industry. Green Seal™-certified and available in a variety of sheet counts.

EcoSoft® Toilet Seat Covers

EcoSoft® toilet seat covers provide maximum sanitary protection and are Green Seal™-certified.



Controlled Roll Towels







No.		Name	Color	Dispenser	Roll Width	Feet/Roll	Rolls/Case	Feet/Case	Cases/Unit	Cases/ Even Layer	Average Case Cube
31000		EcoSoft®	Natural	89000, 80010, 86800, 87510, 89500	8"	1,000	6	6,000	55	5	1.81
31300		EcoSoft®	Natural	89000, 80010, 86800, 87510, 89500	8"	800	6	4,800	55	5	1.82
31400		EcoSoft®	Natural White	89000, 80010, 86800, 87510, 89500	8"	800	6	4,800	55	5	1.82
31060		EcoSoft®	Natural	86600, 80010, 86800, 87510, 89500	8"	550	6	3,300	88	8	1.16
21400		EcoSoft®	Natural White	86600, 80010, 86800, 87510, 89500	8"	425	12	5,100	48	8	2.22
31900		EcoSoft®	White	89000, 80010, 86800, 87510, 89500	8"	800	6	4,800	55	5	1.82
31500		EcoSoft®	Natural	89000, 80010, 86800, 87510, 89500	8"	630	6	3,780	55	5	1.82
31600		EcoSoft®	White	89000, 80010, 86800, 87510, 89500	8"	630	6	3,780	55	5	1.82
20100		EcoSoft®	Natural	86600, 80010, 86800, 87510, 89500	8"	425	12	5,100	48	8	2.14

CenterPull Roll Towels







No.		Name	Color	Ply	Roll Width Sheet Size (W" x L")	Feet/Roll	Rolls/Case	Feet/Case	Cases/Unit	Cases/ Even Layer	Average Case Cube
06002		EcoSoft®	White	Double	7 x 12	600	6	3,600	60	5	1.70

EcoSoft®





Universal Roll Towels

No.		Name	Color	Dispenser	Roll Width (Sheet Size)	Feet/Roll	Rolls/Case	Feet/Case	Cases/Unit	Cases/ Even Layer	Average Case Cube
45800		EcoSoft®	Natural	16000	8"	800	6	4,800	55	5	1.82
45900		EcoSoft®	Natural White	16000	8"	800	6	4,800	55	5	1.82
46000		EcoSoft®	Natural	16000	8"	425	12	5,100	42	7	2.36
46300		EcoSoft®	Natural White	16000	8"	425	12	5,100	42	7	2.36
45600		EcoSoft®	Natural White	16000	8"	350	12	4,200	48	8	2.04
46200		EcoSoft®	Natural	16000	8"	350	12	4,200	54	9	2.04
45700		EcoSoft®	White	16000	8"	800	6	4,800	55	5	1.82
46500		EcoSoft®	White	16000	8"	425	12	5,100	42	7	2.36
45500		EcoSoft®	White	16000	8"	350	12	4,200	48	8	2.04

Folded Towels

No.		Name	Color	Dispenser	Sheet Size (W" x L')	Towels/Package	Packages/Case	Towels/Case	Cases/Unit	Cases/Even Layer	Average Case Cube
48000		EcoSoft® Multifold	Natural	53200, 53500	9½ x 9½	250	16	4,000	70	7	1.55
48300		EcoSoft® Multifold	Natural White	53200, 53500	9½ x 9½	250	16	4,000	70	7	1.55
47000		EcoSoft® Singlefold	Natural	53200, 53500, 51000	9 x 10	250	16	4,000	60	6	1.90
47300		EcoSoft® Singlefold	Natural White	53200, 53500, 51000	9 x 10	250	16	4,000	60	6	1.90
49300		EcoSoft® C-Fold	Natural White	53200, 53500	10½ x 13	200	12	2,400	72	8	1.47
48500		EcoSoft® Multifold	White	53200, 53500	9½ x 9½	250	16	4,000	70	7	1.55
47500		EcoSoft® Singlefold	White	53200, 53500, 51000	9 x 10	250	16	4,000	60	6	1.90
49500		EcoSoft® C-Fold	White	53200, 53500	10½ x 13	200	12	2,400	72	8	1.47

Household Roll Towels

No.		Name	Ply	Sheet Size (W" x L")	Sheets/Roll	Rolls/Case	Sheets/Case	Cases/Unit	Cases/Even Layer	Average Case Cube
40000		EcoSoft®	Double	11 x 9	100	30	3,000	24	6	4.21
41000		EcoSoft®	Double	11 x 9	90	30	2,700	24	6	4.21
41859		EcoSoft®	Double	11 x 9	85	30	2,550	24	6	4.21

EcoSoft®

Silhouette® Toilet Seat Cover Dispenser (10/Case)

No.	Dispenser Size (W" x H" x D")	Dispenser Weight	Case Size (W" x H" x D")	Cases/Unit	Average Case Cube
19510 Black	16½ x 11½ x 3½	1 lbs.	24¾ x 17¾ x 13½	28	3.07







Toilet Seat Covers

No.	Name	Dispenser	Sheet Size (W" x L")	Sheets/Package	Packages/Case	Sheets/Case	Cases/Unit	Cases/ Even Layer	Average Case Cube
19490	 EcoSoft®	19510	14½ x 17	250	20	5,000	50	10	1.47







Facial Tissue

No.	Name	Ply	Box	Sheet Size (W" x L")	Sheets/Box	Boxes/Case	Sheets/Case	Cases/Unit	Cases/ Even Layer	Average Case Cube
15000	 EcoSoft®	Double	Flat	8 x 8	160	30	4,800	48	6	2.22
13000	EcoSoft®	Double	Flat	8 x 8	100	30	3,000	56	8	1.47





Controlled Bath Tissue

No.	Name	Ply	Emboss	Dispenser	Sheet Size (W" x L")	Sheets/Roll	Rolls/Case	Sheets/Case	Cases/Unit	Cases/ Even Layer	Average Case Cube
60090	 EcoSoft® High-Capacity OptiCore®	Double	—	80400	3¾ x 3½	2,000	12	24,000	60	5	1.53
12990	 EcoSoft® OptiCore®	Single	Pebble	80200, 80300, 82300	3¾ x 4	1,755	36	63,180	48	6	2.74
61990	 EcoSoft® OptiCore®	Double	Floral	80200, 80300, 82300	3¾ x 4	865	36	31,140	48	6	2.74
61890	 EcoSoft® OptiCore® RC	Double	Pebble	19800	3¾ x 3¾	800	36	28,800	48	6	2.05
12300	EcoSoft®	Single	Pebble	72300, 88400	3¾ x 4	1,232	48	59,136	36	6	2.88
61600	EcoSoft®	Double	Pebble	72300, 88400	3¾ x 4	616	48	29,568	36	6	2.43

Universal Bath Tissue

No.		Name	Ply	Dispenser	Sheet Size (W' x L')	Sheets/Roll	Rolls/Case	Sheets/Case (Feet)	Cases/Unit	Cases/Even Layer	Average Case Cube
14800		EcoSoft®	Single	72200	4¾ x 3¾	1,000	48	48,000	45	9	2.58
54900		EcoSoft®	Double	72200	4¾ x 3¾	500	96	48,000	25	5	5.09
14000		EcoSoft®	Single	72200	4 x 3¾	1,000	96	96,000	25	5	4.68
54000		EcoSoft®	Double	72200	4 x 3¾	500	96	48,000	25	5	4.68
54800		EcoSoft®	Double	72200	4 x 3¾	500	48	24,000	45	9	2.37
50000		EcoSoft®	Double	72200	4 x 4½	500	96	48,000	25	5	4.68

Jumbo Roll Bath Tissue

No.		Name	Ply	Dispenser	Sheet Size (W' x L')	Sheets/Roll	Rolls/Case	Sheets/Case (Feet)	Cases/Unit	Cases/Even Layer	Average Case Cube
02001		EcoSoft®	Single	88700, 88800, 88900	3½ x 2,000'	–	12	(24,000)	54	6	2.04
10020		EcoSoft®	Double	88700, 88800, 88900	3½ x 1,000'	–	12	(12,000)	54	6	2.04
20020		EcoSoft®	Double	88700	3½ x 2,000'	–	6	(12,000)	54	6	1.89
40010		EcoSoft®	Single	88700	3½ x 4,000'	–	6	(24,000)	54	6	1.89

Dubl-Tough®

Industrial Wipers

Dubl-Tough® industrial wipers provide versatility ranging from light to heavy-duty applications. Dubl-Tough® wipers are strong, soft and absorbent and are offered in two substrates and packaging configurations.



Heavy Duty: Ultra Dubl-Tough®

- Double recycle (DRC) substrate
- Perfect for absorbing liquids and leaves surfaces streak-free
- Ideal for use with chemical solvents



Single Duty: Mighty Dry Dubl-Tough®

- Maximum strength, absorbency and softness
- Ideal for light oil, dirt and water
- Virtually lint free

Dubl-Tough® Industrial Wipers

No.	Name	Grade	Color	Packaging	Sheet Size (W" x L")	Wipers/Package	Packages/Case	Wipers/Case	Cases/Unit	Cases/Even Layer	Average Case Cube
03380	Ultra Dubl-Tough®	DRC Wiper	White	1/4 Fold Poly	12¼ x 13	50	20	1,000	42	6	2.14
03362	Mighty Dry Dubl-Tough®	Scrim Paper	White	Pop-Up Box	9¾ x 16¾	125	8	1,000	48	8	2.12

Sirrus® Household Roll Towel

No.	Name	Ply	Sheet Size (W" x L")	Sheets/Roll	Rolls/Case	Sheets/Case	Cases/Unit	Cases/Even Layer	Average Case Cube
40700	Sirrus®	2	11 x 9	70	30	2,100	24	6	4.21

Sirrus®

Household Roll Towel



Sirrus® Household Roll Towels

Sirrus® household roll towels feature packaging compliant for retail sale. Sirrus® has an attractive quilted diamond emboss creating soft and absorbent household towels.

Dari-Towels®

Single-use Wausau Paper® Dari-Towels® protect profits by helping control the spread of infectious mastitis. More sanitary than rags or sponges, Dari-Towels® provide a set of clean, absorbent prep towels for each cow, minimizing the chance of cross-contamination in the herd.



Advanced Scrubbing Dari-Towels®

Thick and absorbent 39020 Dari-Towels® are made with ATMOS technology for fast, thorough wiping and drying resulting in exceptional sanitary protection.



General Purpose Dari-Towels®

The 47010 and 25000 Dari-Towels® offer versatility for wiping and drying. Made entirely from 100% recovered fibers, 47010 and 25000 Dari-Towels® offer an alternative for environmentally-conscious dairy farms.



Pre-Dip Dari-Towels®

Used regularly, pre-dip towels safeguard the herd and reduce the spread of infectious mastitis. This helps to minimize veterinary expenses and lower overall operating costs.

No.	Name	Color	Dispenser	Sheet Size (W" x L")	Towels/Package	Packages/Case	Towels/Case	Cases/Unit	Cases/Even Layer	Average Case Cube
25000	Dari-Towels® (2-Ply)	Natural White	53200, 53500, 51000	9 x 10	150	15	2,250	60	6	1.91
34000	Pre-Dip Dari-Towels®	Natural	53200, 53500, 51000	9 x 10	268	10	2,680	72	8	1.40
39020	Dari-Towels®	White	53200, 53500, 51000	9 x 10	200	16	3,200	60	6	1.90
47010	Dari-Towels®	Natural	53200, 53500, 51000	9 x 10	250	16	4,000	60	6	1.90



ALLIANCE®

wave'nDRY®

optiSERV_{hybrid}®

optiSERV®

optiSERV_{accent}®

CONTROLLED

TOWEL

DISPENSING

SYSTEM

No.

89000



Description
Alliance®

Color

Black

Dispenser Size
(W" x H" x D")

12¹¹/₁₆ x 19⁵/₁₆ x 11

Dispenser Weight

10.5 lbs.

Case Size
(W" x H" x D")

19⁵/₈ x 11⁵/₈ x 13¹/₈

Cases/Unit

49

Average
Case Cube

1.73

89080 Special Order



High-Capacity Electronic Dispensing

With twice the capacity of typical electronic towel dispensers, the Alliance® offers the highest capacity in the industry. Unlike traditional roll towel dispensers, the Alliance® dispenser's revolutionary design accommodates two full rolls of towels – up to 2,000' – keeping high-traffic areas up and running while reducing maintenance.

Simply Intelligent

Alliance® seamlessly transfers between rolls without the need to move stub rolls. This smart dispenser prepares newly loaded rolls, while continuing to utilize the smaller roll for optimum efficiency. Battery and product status indicator lights provide visual alerts to streamline service visits.

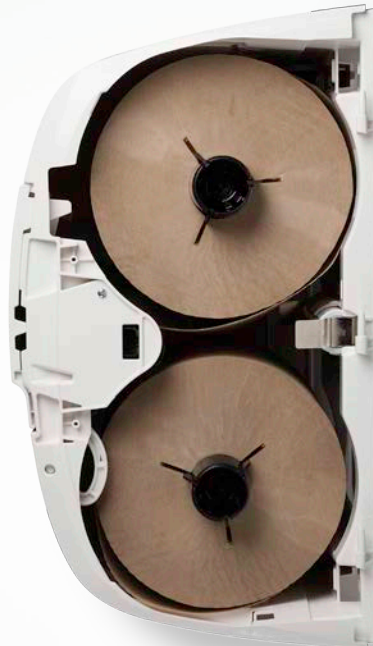

Customize for Your Environment

Tailor the Alliance® to any heavy traffic area. Offering selectable dispense modes, the Alliance® has settings to receive a towel upon the wave of a hand or arm (valet) or to automatically dispense a towel when one is taken (on demand). Towel length can be adjusted based on facility or user preference to 11" or 18" per hand dry. Alliance® is configured to be serviced from either the right or left increasing the options for placement.

wave'nDRY®

No. 80010

Description Wave'n Dry®
Translucent Color Black
Dispenser Size (W" x H" x D") 12 x 15 $\frac{1}{8}$ x 10 $\frac{3}{8}$
Dispenser Weight 8.2 lbs.
Case Size (W" x H" x D") 16 $\frac{3}{8}$ x 12 $\frac{3}{8}$ x 12 $\frac{3}{8}$
Cases/Unit 48
Average Case Cube 1.48







Electronic Convenience for Automated Washrooms

The Wave'n Dry® dispenser is a pioneer in the touch-free towel dispensing market. With no levers, buttons or cranks, the Wave'n Dry® dispenses a single towel at the wave of a hand, ensuring that the only thing you touch is your personal towel. Towels are stored fully protected inside the dispenser until you request service, which is particularly important in public washrooms, food preparation areas and healthcare environments where prevention of cross-contamination is critical.

Controlled-Use Dispensing

Tailor dispensing to your facility's needs by choosing a pre-set towel length of 8", 11", 16 $\frac{1}{2}$ ", or 22" and choose the optimal settings for delay between cycles and sensor sensitivity to prevent waste while meeting user needs.

	80020 Water Resistant
	80030 Special Order
	80040 Special Order
	80050 Special Order
	80060 Special Order

No.
87510



Description OptiServ Hybrid®
Translucent Color Black
Dispenser Size (W" x H" x D") 12 $\frac{1}{8}$ x 16 $\frac{13}{16}$ x 9 $\frac{13}{16}$
Dispenser Weight 9.35 lbs.
Case Size (W" x H" x D") 16 $\frac{7}{8}$ x 10 $\frac{1}{8}$ x 12 $\frac{1}{4}$
Cases/Unit 100
Average Case Cube 1.21

optiSERV^{hybrid}®







Flexibility Built Into a Functional and Attractive Design

Unique and elegant, the OptiServ Hybrid® offers the benefits of electronic touch-free dispensing as well as the convenience of mechanical dispensing when desired. In either mode the OptiServ Hybrid® delivers a single pre-measured towel that encourages users to take only what is needed to reduce waste making it ideal for office buildings, colleges and universities and high-traffic washrooms.

Controlled-Use Dispensing

Metered dispensing discourages waste and controls cost. A locking cover prevents pilferage.

	87530 Special Order
	87540 Special Order
	87550 Special Order
	87560 Special Order

optiSERV®



Rugged Reliability for High-Traffic Washrooms

The OptiServ® hands-free dispensing system offers the hygiene of hands-free dispensing without need for batteries. The OptiServ® is easy to use and accommodates up to 1,000 feet of toweling, making it ideal for high-traffic facilities where cleanliness is essential.

Controlled-Use Dispensing

Each pull of the exposed towel dispenses and cuts a single 11-inch towel to discourage waste and control cost. A locking cover prevents pilferage.

No.
86800



Description
OptiServ®

Translucent Color
Black

Dispenser Size
(W" x H" x D")
12¹/₈ x 16¹³/₁₆ x 9¹³/₁₆

Dispenser Weight
6.85 lbs.

Case Size
(W" x H" x D")
16¹/₈ x 10¹/₈ x 12¹/₄

Cases/Unit
100

Average
Case Cube
1.21

86860

86830 Special Order

86840 Special Order

86850 Special Order

No.
86600



Description
OptiServ
Accent®

Translucent Color
Black

Dispenser Size
(W" x H" x D")
12³/₈ x 12⁷/₁₆ x 7¹/₂

Dispenser Weight
5.65 lbs.

Case Size
(W" x H" x D")
12³/₄ x 12⁵/₈ x 7³/₄

Cases/Unit
144

Average
Case Cube
0.72

86630 Special Order

86640 Special Order

86650 Special Order

86660 Special Order

optiSERV^{accent}®



The Perfect Solution for Small Spaces









The OptiServ Accent® is ideal for environments where space is limited. Designed to fit tight spaces previously reserved for folded towels, the OptiServ Accent® provides the operational benefits of a larger roll towel dispenser in a compact and attractive design.

Controlled-Use Dispensing

Each pull of the exposed towel dispenses a single 11-inch towel to discourage waste and control cost. A locking cover prevents pilferage.

Dispenser colors noted as special order require a minimum pallet quantity and lead time applies.

CONTROLLED ROLL TOWELS: SPECIFICATIONS

No.	Name	Color	Roll Width	Feet/Roll	Rolls/Case	Feet/Case	Cases/Unit	Cases/ Even Layer	Average Case Cube
31040	 DublNature®	White	8"	1,000	6	6,000	55	5	1.91
31000	 EcoSoft®	Natural	8"	1,000	6	6,000	55	5	1.81
38040	 DublNature®	White	8"	800	6	4,800	55	5	1.91
31300	 EcoSoft®	Natural	8"	800	6	4,800	55	5	1.82
31400	 EcoSoft®	Natural White	8"	800	6	4,800	55	5	1.82
30620	 Artisan®	White	8"	600	6	3,600	55	5	1.93
31900	EcoSoft®	White	8"	800	6	4,800	55	5	1.82
31500	EcoSoft®	Natural	8"	630	6	3,780	55	5	1.82
31600	EcoSoft®	White	8"	630	6	3,780	55	5	1.82
Dispenser Series: Alliance® (89000), Wave'n Dry® (80010), OptiServ Hybrid® (87510), OptiServ® (86800)									
31060	 EcoSoft®	Natural	8"	550	6	3,300	88	8	1.16
34540	 DublNature®	White	8"	450	12	5,400	48	8	2.13
21400	 EcoSoft®	Natural White	8"	425	12	5,100	48	8	2.22
20100	EcoSoft®	Natural	8"	425	12	5,100	48	8	2.14
Dispenser Series: OptiServ Accent® (86600), Alliance® (89000), Wave'n Dry® (80010), OptiServ Hybrid® (87510), OptiServ® (86800)									

HAND HYGIENE: **PAPER TOWELS** VS. AIR DRYERS



The World Health Organization (WHO) and Centers for Disease Control and Prevention (CDC) recommend hands be washed 40-60 seconds and thoroughly dried using a paper towel. To prevent potential cross-contamination, use the paper towel to turn off the water faucet.²

Myth:

Warm air and jet air dryers are **more hygienic** than paper towels.

Did you know?

Warm air dryers **increase** the number of bacteria on fingertips and palms by up to 254%.¹

Jet air dryers **increase** the number of bacteria on both the palms and fingertips by up to 42%.¹

Fact:

Using paper towels after washing hands **reduces the number of bacteria** both on the palms and fingertips by up to 77%.¹

Myth:

Warm air and jet air dryers are **less likely to contaminate** the washroom environment.

Did you know?

Warm air dryers are capable of blowing bacteria and potentially contaminating the washroom up to **nine inches away**.¹

Jet air dryers that claim to blow air out of the unit at speeds of 400 mph are capable of blowing bacteria up to **six feet away**, potentially contaminating the washroom and other occupants.¹

Fact:

Using paper towels after washing hands showed **no significant potential of cross-contamination**.¹

¹Comparison of the Drying Efficiency and Hygiene of Paper Towels with Electric Hand Dryers, prepared by Keith Redway and Shameem Fawdar, School of Biosciences, University of Westminster, London, 2008.

²World Health Organization, Guidelines on Hand Hygiene in Health Care (www.who.int/gpsc/en), 2009; Centers for Disease Control and Prevention (www.cdc.gov/cleanhands), 2008.

CONTROLLED ROLL TOWEL DISPENSING SYSTEM



89500

Compatible™ Lever

No.	Description	Translucent Color	Dispenser Size (W" x H" x D")	Dispenser Weight	Case Size (W" x H" x D")	Cases/Unit	Average Case Cube
89500	 Compatible™ Lever	Black	11½ x 15⅞ x 10½	7.2 lbs.	11⅞ x 16 x 11¼	40	1.25

UNIVERSAL ROLL TOWEL DISPENSERS





16000

Silhouette® Roll Towel



68100

CenterPull Dispenser

No.	Description	Translucent Color	Dispenser Size (W" x H" x D")	Dispenser Weight	Case Size (W" x H" x D")	Cases/Unit	Average Case Cube
16000	 Silhouette® Roll Towel	Black	10⅝ x 15¾ x 8¾	6.7 lbs.	18⅞ x 10⅝ x 10¼	72	1.17
68100	 CenterPull	Black	10 x 12½ x 10	2.8 lbs.	11 x 13½ x 11	108	0.95

UNIVERSAL FOLDED TOWEL DISPENSERS



53200

Silhouette® Compact Folded Towel







53500

Silhouette® Folded Towel



53800

OptiFold® ES Folded Towel

No.	Description	Translucent Color	Dispenser Size (W" x H" x D")	Dispenser Weight	Case Size (W" x H" x D")	Cases/Unit	Average Case Cube
51000	 Single Folded Towel (not pictured)	Steel Painted White	11 ³ / ₄ x 9 ¹ / ₄ x 5 ⁵ / ₈	4.6 lbs.	12 x 9 ⁵ / ₈ x 5 ³ / ₄	96	0.50
53200	 Silhouette® Compact Towel	Black Special Order: White [53260]	12 ³ / ₈ x 13 x 4 ⁷ / ₈	2.3 lbs.	12 ¹³ / ₁₆ x 13 ⁷ / ₈ x 5 ⁷ / ₁₆	189	0.56
53500	 Silhouette® Folded Towel	Black White [53560]	12 ¹ / ₄ x 16 ³ / ₄ x 5	3.3 lbs.	13 ¹ / ₂ x 17 ¹ / ₄ x 5 ¹ / ₂	153	0.74
53800	 OptiFold® ES Folded Towel	Black Special Order: White [53860]	8 ¹ / ₂ x 10 ⁷ / ₁₆ x 3 ⁷ / ₈	1.25 lbs.	10 ¹ / ₂ x 9 ³ / ₃₂ x 4	432	0.26



dublSERV^{HC}

REVOLUTION[®]

dublSERV^{vertical}

dublSERV^{side-by-side}

optiCORE[®]

CONTROLLED

BATH TISSUE

DISPENSING

SYSTEM



Wausau Paper offers patented OptiCore® technology, reducing maintenance time and costs.

Our OptiCore® technology, combined with our Revolution® and DublServ® dispensing systems, ensures maximum use of each roll in the dispenser before advancing to the next roll. This controlled-use reduces product waste and cost.

OptiCore® technology offers a two-part core for controlled-use and more than 25% reduction in core material for more environmentally preferable packaging

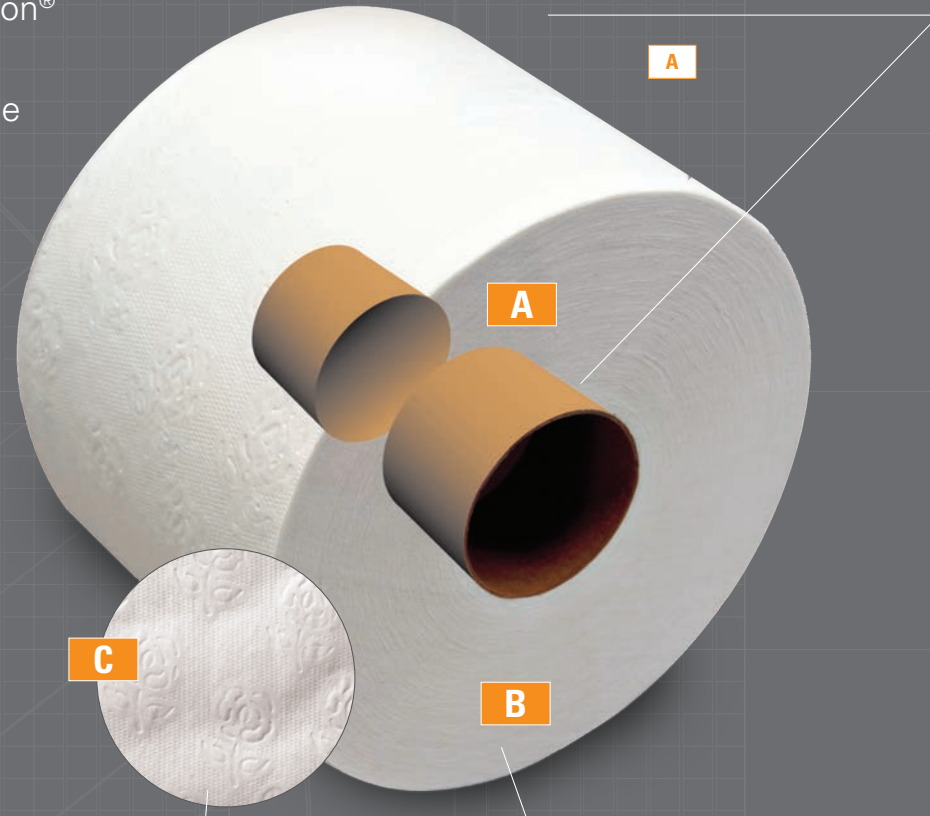

C

Attractive floral embossing on most 2-ply products

B

High sheet count for maximum capacity

A

A

No.
80400



Description
DublServ® HC

Translucent Color
Black

Dispenser Size
(W" x H" x D")
16⁵/₈ x 9¹⁵/₁₆ x 5¹/₄

Dispenser Weight
2.8 lbs.

Case Size
(W" x H" x D")
17 x 5³/₄ x 10⁵/₁₆

Cases/Unit
64

Average
Case Cube
0.60

80480

80430 Special Order

80440 Special Order

80450 Special Order

dublSERV[®] HC

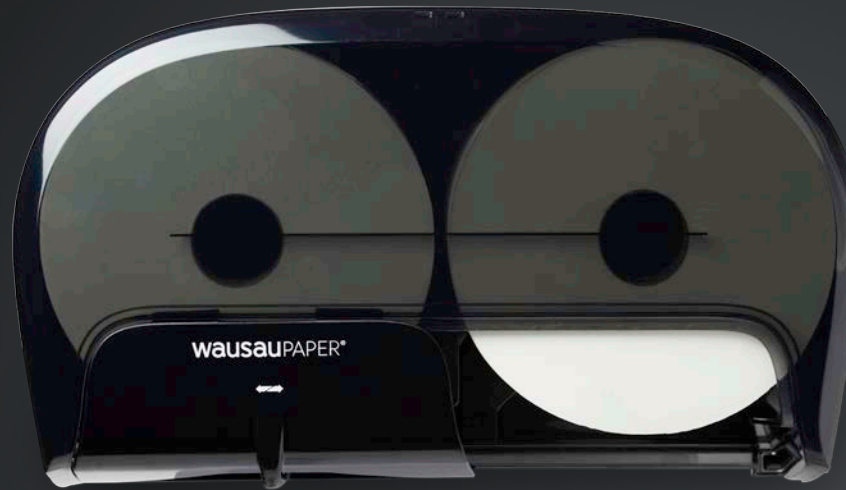

Highest Capacity OptiCore[®] System

The DublServ[®] HC provides an attractive alternative to coreless and mini jumbo tissue dispensers. Designed to lower maintenance costs in the busiest washrooms, the DublServ[®] HC accommodates two 2,000-sheet rolls of high-quality perforated tissue. Patented OptiCore[®] technology prevents stub roll waste associated with coreless designs and ensures complete utilization since each roll is completely depleted before the next roll is accessible. The DublServ[®] HC features a locking cover to prevent product pilferage.







REVOLUTION®

No.	80300
	
Description	Revolution®
Translucent Color	Black
Dispenser Size (W" x H" x D")	14 ¹ / ₁₆ x 14 ⁹ / ₁₆ x 6 ⁵ / ₁₆
Dispenser Weight	3.6 lbs.
Case Size (W" x H" x D")	14 ⁷ / ₁₆ x 14 ¹¹ / ₁₆ x 6 ¹¹ / ₁₆
Cases/Unit	60
Average Case Cube	0.81



High-Traffic OptiCore® Dispensing

The Revolution® dispensing system is designed to minimize maintenance and maximize cost savings for high-traffic areas. With its revolving design and our patented OptiCore® tissue, the Revolution® ensures that a roll is completely depleted before the dispenser will advance to the next roll, eliminating waste. Capacity for three OptiCore® tissue rolls allows for longer periods between maintenance. The Revolution® features a locking cover to prevent product pilferage and is available in five color choices.

	80330 Special Order
	80340 Special Order
	80350 Special Order
	80360 Special Order





No.	82300
	
Description	DublServ® Vertical
Translucent Color	Black
Dispenser Size (W" x H" x D")	6 ³ / ₄ x 12 ⁵ / ₁₆ x 7
Dispenser Weight	2.0 lbs.
Case Size (W" x H" x D")	7 ¹ / ₄ x 12 ⁵ / ₁₆ x 7 ¹ / ₂
Cases/Unit	120
Average Case Cube	0.40



dublSERV® vertical

OptiCore® Dispensing for Smaller Spaces

The DublServ® vertical tissue dispenser is ideal for environments where horizontal space is limited. The DublServ® dispensing system holds two rolls of patented OptiCore® tissue and is designed to ensure the lower roll is completely utilized before the upper roll can be accessed, eliminating waste and controlling cost. The DublServ® features a locking cover to prevent product pilferage.

	82330 Special Order
	82340 Special Order
	82350 Special Order
	82360 Special Order

dublSERV[®] side-by-side



Traditional Footprint OptiCore[®] Dispensing

The DublServ[®] Side-by-Side tissue dispensing system holds two rolls of patented OptiCore[®] tissue. With a controlled use design, the DublServ[®] dispensing system reduces waste and cost by ensuring each roll is completely utilized before the next roll is accessible. The DublServ[®] Side-by-Side features a locking cover to prevent product pilferage.

No.
80200



Description
DublServ[®]
Side-by-Side

Translucent Color
Black

Dispenser Size
(W" x H" x D")
11¹/₁₆ x 8¹³/₁₆ x 7³/₁₆

Dispenser Weight
2.2 lbs.

Case Size
(W" x H" x D")
11³/₈ x 8¹⁵/₁₆ x 7⁵/₈

Cases/Unit
102

Average
Case Cube
0.44

80260

80230 Special Order

80240 Special Order

80250 Special Order

Dispenser colors noted as special order require a minimum pallet quantity and lead time applies.

No.
19800

Description
OptiCore[®]
Recessed Adapter

Color
Stainless Steel

Dispenser Size
(W" x H" x D")
4⁹/₁₆ x 8¹³/₁₆ x 4⁷/₁₆

Dispenser Weight
1.43 lbs.

Case Size
(W" x H" x D")
13⁵/₈ x 20⁵/₁₆ x 6¹/₄

Cases/Unit
35 (12 per case)

Average
Case Cube
1.00



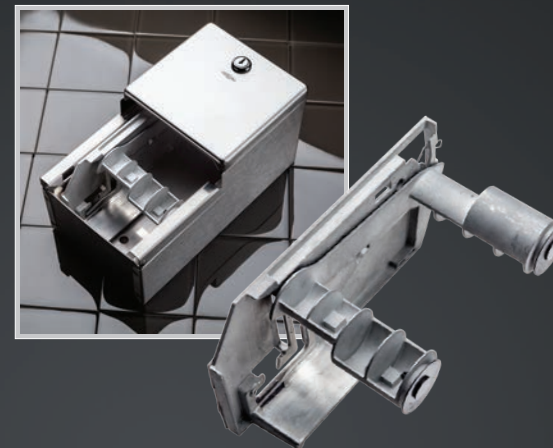

optiCORE[®] recessed adapter



Adapts Existing Dispensers to Reduce Cost

The OptiCore[®] Recessed Adapter quickly and easily converts many existing 2-roll vertical recessed dispensers to the capacity of three rolls without removing dispensers. Using patented OptiCore[®] RC tissue, dispenser sheet capacity is increased by 50% versus typical universal tissue. OptiCore[®] technology lowers maintenance time and reduces waste by ensuring each roll is fully utilized before the next is accessible.

OPTICORE® BATH TISSUE: SPECIFICATIONS

No.	Name	Ply	Emboss	Sheet Size (W" x L")	Sheets/Roll	Rolls/Case	Sheets/Case	Cases/Unit	Cases/ Even Layer	Average Case Cube
60090	 EcoSoft® High-Capacity	Double	—	3¾ x 3½	2,000	12	24,000	60	5	1.58
12990	 EcoSoft®	Single	Pebble	3¾ x 4	1,755	36	63,180	48	6	2.74
61990	 EcoSoft®	Double	Floral	3¾ x 4	865	36	31,140	48	6	2.74
62090	 DublNature®	Double	Floral	3¾ x 4	865	36	31,140	48	6	2.74
61890	 EcoSoft® RC	Double	Pebble	3¾ x 3¾	800	36	28,800	48	6	2.05
06390	DublSoft®	Double	Floral	3¾ x 4	800	36	28,800	48	6	2.74
06290	DublSoft® RC	Double	Floral	3¾ x 3¾	800	36	28,800	48	6	2.05



DublSoft

DublSoft® premium OptiCore® 2-ply bath tissue is for those customers who demand the maximum in strength, brightness and softness. DublSoft® products will meet that demand. This tissue also offers an attractive premium embossing pattern that any customer can appreciate. DublSoft® packaging is designed for the most upscale applications and is an attractive addition to any décor.



DublNature®

DublNature® OptiCore® tissue offers superior quality with a stylish and sophisticated appearance. DublNature® products are made from a superior grade of 100% recycled wastepaper for exceptional brightness and overall quality. Featuring consumer-like embossing and environmentally preferable packaging, Green Seal™-certified DublNature® tissue is ideal for a wide range of applications.



EcoSoft®

EcoSoft® OptiCore® bath tissue is certified as environmentally preferable by Green Seal, Inc., in Washington, DC. Made from 100% recycled fiber with a minimum of 25% post-consumer waste content, EcoSoft® far exceeds the EPA guidelines. The tissue products also feature environmentally preferable packaging. Available in high-capacity, standard, or recessed capacity OptiCore® rolls.

UNIVERSAL BATH TISSUE DISPENSERS



72200
DublServ® 2-Roll Tissue







88700
Jumbo Roll Tissue



88800
9" Roll Tissue



88900
Side-by-Side 9" Roll Tissue

No.	Description	Translucent Color	Dispenser Size (W" x H" x D")	Dispenser Weight	Case Size (W" x H" x D")	Cases/Unit	Average Case Cube
72200	 DublServ®	Black	6 ⁵ / ₈ x 13 ¹ / ₈ x 6 ¹ / ₈	2.2 lbs.	6 ⁷ / ₈ x 13 ⁵ / ₈ x 6 ⁵ / ₈	105	0.35
88700	 Jumbo Roll Tissue	Black	13 ¹ / ₄ x 14 ¹⁵ / ₁₆ x 6	2.8 lbs.	13 ¹ / ₂ x 15 ⁹ / ₁₆ x 6 ¹ / ₈	60	0.75
88800	 9" Roll Tissue	Black	9 ⁵ / ₈ x 11 ¹ / ₈ x 5 ¹ / ₄	1.75 lbs.	10 ⁷ / ₈ x 12 x 6	84	0.45
88900	 Side-by-Side 9"	Black	20 ¹ / ₄ x 11 ¹ / ₄ x 5 ³ / ₈	3.75 lbs.	20 ⁷ / ₈ x 5 ⁷ / ₈ x 12 ¹ / ₈	84	0.86



GREEN SEAL STANDARDS FOR HAND SOAPS (GS-41A)

- Must meet or exceed applicable governmental and industrial safety
- Cannot be a skin sensitizer or skin irritant
- No antibacterial, disinfecting, antiseptic or sanitizing product claims can be made
- Cannot be formulated or manufactured with phosphates, NTA, EDTA, APEOs, halogenated organic solvents, butoxy-ethanol, or with any chemicals that are proven, probable, or possible carcinogens
- Fragrances used must be produced or handled following the code of practice of the International Fragrance Association; fragrances must be declared on the product label and MSDS sheets
- Can only be formulated or manufactured with food grade dyes
- Cannot contain volatile organic compounds in excess of 1%
- Based on standard use, hand cleaners cannot be toxic to aquatic life and must be readily biodegradable
- Must include detailed instructions for proper use to maximize product performance and minimize waste
- Must not be packaged in a bag in box packaging
- Packaging must be recyclable (an exception shall be made for lightweight flexible packaging, such as pouches or bags, that represent at least 20% reduction in material use when compared with rigid packaging); efforts must be made to ensure packaging contains post-consumer recycled content

opti**SOURCE** convertible®

SILHOUETTE®

HAND CARE SYSTEM

optiSOURCE convertible® HAND CARE SYSTEM



12503

Foam Lotion Soap

Ideal for those who prefer the convenience of having soap pre-lathered before washing, this gentle Green Seal™-certified foam lotion soap provides a convenient and pleasing hand washing experience.

- Pre-measured dose: 0.75mL
- 1250mL cartridge capacity
- Fits OptiSource Convertible® electronic or manual dispensers



12504

Antibacterial Soap

This OptiSource® antibacterial foam hand soap produces a non-sticky foam that contains unique non-drying, conditioning and moisturizing ingredients. This leaves skin feeling soft, refreshed and silky, while helping to reduce germs that cause illness.

- Pre-measured dose: 0.75mL
- Triclosan Free and NSF E2 registered
- Contains 0.13% Benzalkonium Chloride to effectively eliminate bacteria



SILHOUETTE®



95100

Silhouette® Soap Products

- Ideal for multipurpose use in washrooms
- Certified by Green Seal, Inc.
- Replaces expensive, unsanitary bar soap and low-quality liquid and powder soaps

No.	Description	Color	Cartridge Capacity	Items/Case	Cases/Unit	Cases/ Even Layer	Average Case Cube
12503	 OptiSource® Foam Lotion Soap	White	1250mL	4	100	20	0.50
12504	 OptiSource® Antibacterial Foam Soap	White	1250mL	4	100	20	0.50
95100	 Silhouette® Lotion Soap	White	500mL	12	140	20	0.42

OptiSource® Soaps for use with: OptiSource Convertible® Manual (91210), OptiSource Convertible® Electronic (91218)

Silhouette® Lotion Soap for use with: Silhouette® 500mL Dispenser (95270)

No. 91218

Description OptiSource Convertible® Electronic
Translucent Color Black
Dispenser Size (W" x H" x D") 6 ¹¹ / ₁₆ x 11 ¹ / ₈ x 4
Dispenser Weight 1.6 lbs.
Case Size (W" x H" x D") 13 ³ / ₁₆ x 12 ³ / ₁₆ x 14 ⁵ / ₁₆
Item/Case 6
Cases/Unit 84
Average Case Cube 1.33

optiSOURCE convertible®

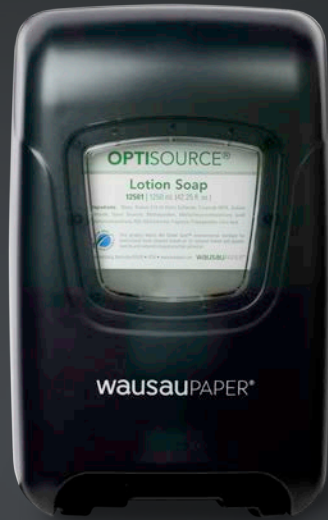
ELECTRONIC



OptiSource Convertible® Electronic

For the ultimate in cleanliness, the electronic OptiSource Convertible® eliminates the need to touch dispensers so hands are not cross-contaminated. When installed according to ADA guidelines, this dispenser is ADA Title III compliant.

- Pre-measured dose: 1.0mL lotion, 0.75mL foam
- Adjustable setting for sensor, dose and speed
- Locking cover prevents product pilferage
- Estimated battery life expectancy 9-12 months dependent upon usage

No. 91210

Description OptiSource Convertible® Manual
Translucent Color Black
Dispenser Size (W" x H" x D") 6 ¹¹ / ₁₆ x 11 ¹ / ₈ x 4
Dispenser Weight 1.6 lbs.
Case Size (W" x H" x D") 13 ³ / ₁₆ x 12 ³ / ₁₆ x 14 ⁵ / ₁₆
Item/Case 6
Cases/Unit 84
Average Case Cube 1.33

optiSOURCE convertible®

MANUAL



OptiSource Convertible® Manual

The manual OptiSource Convertible® has a durable design and can be used with foam or liquid soap cartridges. It is ADA Title III compliant when installed according to ADA guidelines.

- Pre-measured dose: 1.0mL lotion, 0.75mL foam
- Large push bar for easy activation
- Locking cover to prevent product pilferage
- Can convert to electronic touch-free



Most Wausau Paper dispensers are ADA Title III compliant when installed according to ADA guidelines. Product is easily dispensed with one hand, with less than 5 lbs. of force, and without tight grasping, pinching or twisting of the wrist.

Forward Reach for Wall Mounted Dispensers

308.2.1 Where a forward reach is unobstructed, the high forward reach shall be 48 inches (1220mm) maximum and the low forward reach shall be 15 inches (3810mm) minimum above the finish floor or ground. [Section 308.2.1, ADA Accessibility Guidelines]

308.2.2 Where a high forward reach is over an obstruction, the clear floor space shall extend beneath the element for a distance not less than the required reach depth over the obstruction.

The high forward reach shall be 48 inches (1220mm) maximum where the reach depth is 20 inches (510mm) maximum. Where the reach depth exceeds 20 inches (510mm), the high forward reach shall be 44 inches (1120mm) maximum and the reach depth shall be 25 inches (635mm) maximum. [Section 308.2.2, ADA Accessibility Guidelines]

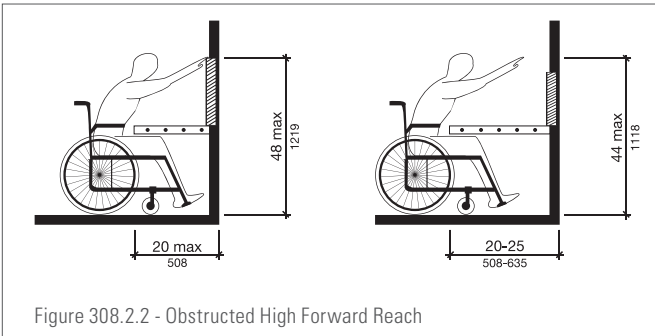

Figure 308.2.2 - Obstructed High Forward Reach

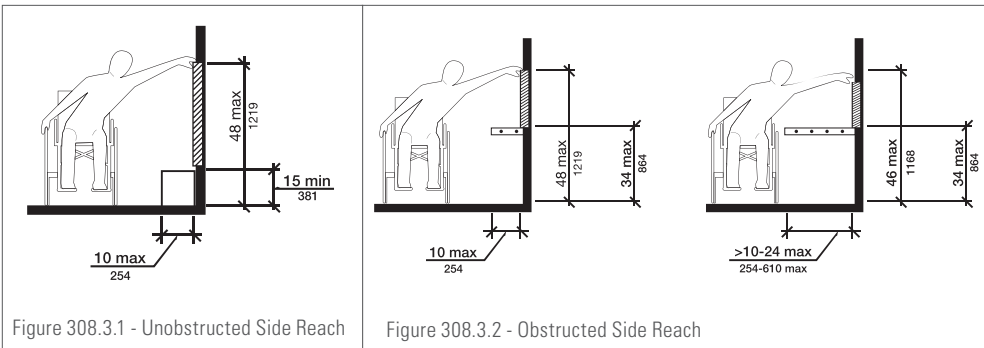

Figure 308.3.1 - Unobstructed Side Reach

Figure 308.3.2 - Obstructed Side Reach

Dispenser Installation in Water Closets and Toilet Compartments

604.7 Toilet paper dispensers shall comply with section 309.4 and shall be 7 inches (180mm) minimum and 9 inches (230mm) maximum in front of the water closet measured to the centerline of the dispenser. The outlet of the dispenser shall be 15 inches (380mm) minimum and 48 inches (1220mm) maximum above the finish floor and shall not be located behind grab bars. Dispensers shall not be of a type that controls delivery or that does not allow continuous paper flow. [Section 604.7, ADA Accessibility Guidelines]

ADVISORY 604.7 If toilet paper dispensers are installed above the side wall grab bar, the outlet of the toilet paper dispenser must be 48 inches (1220mm) maximum above the finish floor and the top of the gripping surface of the grab bar must be 33 inches (840mm) minimum and 36 inches (915mm) maximum above the finish floor.

Dispenser Installation and Side Reach Obstructions

308.3.1 Where a clear floor or ground space allows a parallel approach to an element and the side reach is unobstructed, the high side reach shall be 48 inches (1220mm) maximum and the low side reach shall be 15 inches (380mm) minimum above the finish floor or ground.

EXCEPTION

An obstruction shall be permitted between the clear floor or ground space and the element where the depth of the obstruction is 10 inches (255mm) maximum.

308.3.2 Where a clear floor or ground space allows a parallel approach to an element and the high side reach is over an obstruction, the height of the obstruction shall be 34 inches (865mm) maximum and the depth of the obstruction shall be 24 inches (610mm) maximum.

The high side reach shall be 48 inches (1220mm) maximum for a reach depth of 10 inches (255mm) maximum.

Where the reach depth exceeds 10 inches (255mm), the high side reach shall be 46 inches (1170mm) maximum for a reach depth of 24 inches (610mm) maximum. [Section 308.3, ADA Accessibility Guidelines]

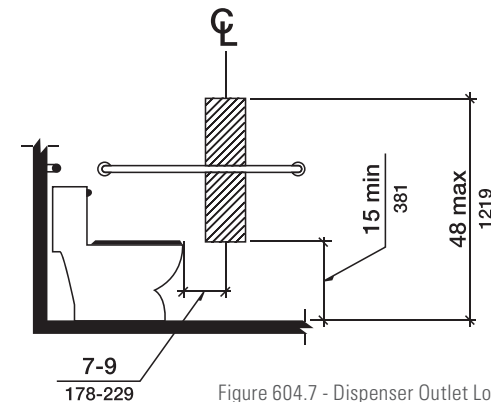

Figure 604.7 - Dispenser Outlet Location

Index by Catalog Number

No.	Description	Pg.	No.	Description	Pg.	No.	Description	Pg.
02001	EcoSoft® Universal Jumbo Tissue.....	21	20100	EcoSoft® Controlled Roll Towel.....	17,30	47000	EcoSoft® Singlefold Towel.....	19
03362	Mighty Dry Dubl-Tough® Wiper.....	22	21400	EcoSoft® Controlled Roll Towel.....	17,30	47010	Dari-Towls® Natural.....	23
03380	Ultra Dubl-Tough® DRC Wiper.....	22	25000	Dari-Towls® (2-Ply).....	23	47300	EcoSoft® Singlefold Towel.....	19
04220	Artisan® Multifold Towel.....	9	30620	Artisan® Controlled Roll Towel.....	9,30	47500	EcoSoft® Singlefold Towel.....	19
04420	Artisan® OptiFold® Towel.....	9	31000	EcoSoft® Controlled Roll Towel.....	17,30	48140	DublNature® Multifold Towel.....	13
04620	Artisan® OptiFold® ES Towel.....	9	31040	DublNature® Controlled Roll Towel.....	13,30	48000	EcoSoft® Multifold Towel.....	19
04820	Artisan® C-Fold Towel.....	9	31060	EcoSoft® Controlled Roll Towel.....	17,30	48300	EcoSoft® Multifold Towel.....	19
06002	EcoSoft® Center Pull Roll Towel.....	17	31300	EcoSoft® Controlled Roll Towel.....	17,30	48440	DublNature® OptiFold® Towel.....	13
06100	DublSoft® Facial Tissue Flat Box.....	11	31400	EcoSoft® Controlled Roll Towel.....	17,30	48500	EcoSoft® Multifold Towel.....	19
06185	DublSoft® Facial Tissue Cube Box.....	11	31500	EcoSoft® Controlled Roll Towel.....	17,30	48640	DublNature® OptiFold® ES Towel.....	13
06290	DublSoft® OptiCore® RC.....	11,40	31600	EcoSoft® Controlled Roll Towel.....	17,30	49140	DublNature® C-Fold Towel.....	13
06325	DublSoft® Controlled Bath Tissue.....	11	31900	EcoSoft® Controlled Roll Towel.....	17,30	49300	EcoSoft® C-Fold Towel.....	19
06348	DublSoft® Bath Tissue.....	11	34000	Dari-Towls® Pre-Dip.....	23	49500	EcoSoft® C-Fold Towel.....	19
06380	DublSoft® Bath Tissue.....	11	34540	DublNature® Controlled Roll Towel.....	13,30	50000	EcoSoft® Universal Bath Tissue.....	21
06390	DublSoft® OptiCore®.....	11,40	38040	DublNature® Controlled Roll Towel.....	13,30	51000	Single Folded Towel Universal Towel Dispenser.....	33
06480	DublSoft® Bath Tissue.....	11	39020	Dari-Towls®.....	23	53200	Silhouette® Compact Black Folded Towel Dispenser.....	33
08540	DublNature® Cube Facial.....	14	40000	EcoSoft® Household Roll Towel.....	19	53260	Silhouette® Compact White Folded Towel Dispenser.....	33
10020	EcoSoft® Universal Jumbo Tissue.....	21	40010	EcoSoft® Universal Jumbo Tissue.....	21	53500	Silhouette® Black Folded Towel Dispenser.....	33
10040	DublNature® Flat Facial.....	14	40700	Sirrus® Household Roll Towels.....	22	53560	Silhouette® White Folded Towel Dispenser.....	33
12300	EcoSoft® Controlled Bath Tissue.....	20	41000	EcoSoft® Household Roll Towel.....	19	53800	OptiFold® ES Black Folded Towel Dispenser.....	33
12503	OptiSource® Foam Lotion Soap.....	44	41859	EcoSoft® Household Roll Towel.....	19	53860	OptiFold® ES White Folded Towel Dispenser.....	33
12504	OptiSource® Antibacterial Foam Soap.....	44	44040	DublNature® Universal Roll Towel.....	13	54000	EcoSoft® Universal Bath Tissue.....	21
12990	EcoSoft® OptiCore®.....	20,40	44840	DublNature® Universal Roll Towel.....	13	54800	EcoSoft® Universal Bath Tissue.....	21
13000	EcoSoft® Facial Tissue Flat Box.....	20	45500	EcoSoft® Universal Roll Towel.....	18	54900	EcoSoft® Universal Bath Tissue.....	21
14000	EcoSoft® Universal Bath Tissue.....	21	45600	EcoSoft® Universal Roll Towel.....	18	59490	DublNature® Universal Bath Tissue.....	14
14800	EcoSoft® Universal Bath Tissue.....	21	45700	EcoSoft® Universal Roll Towel.....	18	59890	DublNature® Universal Bath Tissue.....	14
15000	EcoSoft® Facial Tissue Flat Box.....	20	45800	EcoSoft® Universal Roll Towel.....	18	60090	EcoSoft® High-Capacity OptiCore®.....	20,40
16000	Silhouette® Roll Towel Universal Towel Dispenser.....	32	45900	EcoSoft® Universal Roll Towel.....	18	61600	EcoSoft® Controlled Bath Tissue.....	20
19490	EcoSoft® Toilet Seat Cover.....	20	46000	EcoSoft® Universal Roll Towel.....	18	61890	EcoSoft® OptiCore® RC.....	20,40
19510	Silhouette® Toilet Seat Dispenser.....	20	46200	EcoSoft® Universal Roll Towel.....	18	61990	EcoSoft® OptiCore®.....	20,40
19800	OptiCore® Recessed Adapter.....	39	46300	EcoSoft® Universal Roll Towel.....	18	62090	DublNature® OptiCore®.....	14,40
20020	EcoSoft® Universal Jumbo Tissue.....	21	46500	EcoSoft® Universal Roll Towel.....	18	68100	CenterPull Towel Dispenser.....	32

No.	Description	Pg.	No.	Description	Pg.
72200	DublServ® Black Universal Bath Tissue Dispenser.....	41	86800	OptiServ® Black Controlled Towel Dispenser	29
80010	Wave'n Dry® Black Controlled Towel Dispenser.....	28	86830	OptiServ® Red Controlled Towel Dispenser.....	29
80020	Wave'n Dry® Black Water Resistant Towel Dispenser.....	28	86840	OptiServ® Green Controlled Towel Dispenser	29
80030	Wave'n Dry® Red Controlled Towel Dispenser	28	86850	OptiServ® Blue Controlled Towel Dispenser.....	29
80040	Wave'n Dry® Green Controlled Towel Dispenser.....	28	86860	OptiServ® White Controlled Towel Dispenser.....	29
80050	Wave'n Dry® Blue Controlled Towel Dispenser	28	87510	OptiServ Hybrid® Black Controlled Towel Dispenser.....	28
80060	Wave'n Dry® White Controlled Towel Dispenser	28	87530	OptiServ Hybrid® Red Controlled Towel Dispenser.....	28
80200	DublServ® Side-by-Side Black Bath Tissue Dispenser.....	39	87540	OptiServ Hybrid® Green Controlled Towel Dispenser.....	28
80230	DublServ® Side-by-Side Red Bath Tissue Dispenser.....	39	87550	OptiServ Hybrid® Blue Controlled Towel Dispenser	28
80240	DublServ® Side-by-Side Green Bath Tissue Dispenser.....	39	87560	OptiServ Hybrid® White Controlled Towel Dispenser	28
80250	DublServ® Side-by-Side Blue Bath Tissue Dispenser.....	39	88700	Jumbo Roll Tissue Universal Bath Tissue Dispenser.....	41
80260	DublServ® Side-by-Side White Bath Tissue Dispenser.....	39	88800	9" Roll Tissue Universal Bath Tissue Dispenser	41
80300	Revolution® Black Bath Tissue Dispenser.....	38	88900	Side-by-Side 9"Universal Bath Tissue Dispenser	41
80330	Revolution® Red Bath Tissue Dispenser	38	89000	Alliance® Black Controlled Towel Dispenser.....	26,27
80340	Revolution® Green Bath Tissue Dispenser.....	38	89080	Alliance® White Controlled Towel Dispenser.....	26,27
80350	Revolution® Blue Bath Tissue Dispenser.....	38	89500	Compatible™ Lever Controlled Towel Dispenser.....	32
80360	Revolution® White Bath Tissue Dispenser.....	38	91210	OptiSource Convertible® Black Manual Soap Dispenser	45
80400	DublServ® HC Black Bath Tissue Dispenser.....	37	91218	OptiSource Convertible® Black Electronic Soap Dispenser ..	45
80430	DublServ® HC Red Bath Tissue Dispenser	37	95100	Silhouette® Lotion Soap.....	44
80440	DublServ® HC Green Bath Tissue Dispenser.....	37			
80450	DublServ® HC Blue Bath Tissue Dispenser.....	37			
80480	DublServ® HC White Bath Tissue Dispenser	37			
82300	DublServ® Vertical Black Bath Tissue Dispenser	38			
82330	DublServ® Vertical Red Bath Tissue Dispenser.....	38			
82340	DublServ® Vertical Green Bath Tissue Dispenser	38			
82350	DublServ® Vertical Blue Bath Tissue Dispenser	38			
82360	DublServ® Vertical White Bath Tissue Dispenser	38			
86600	OptiServ Accent® Black Controlled Towel Dispenser.....	29			
86630	OptiServ Accent® Red Controlled Towel Dispenser	29			
86640	OptiServ Accent® Green Controlled Towel Dispenser.....	29			
86650	OptiServ Accent® Blue Controlled Towel Dispenser	29			
86660	OptiServ Accent® White Controlled Towel Dispenser	29			

Availability and specifications are subject to change.



SCA *Care of life*. Because our products make life easier for you and for millions of people around the world. Because our resources and the way we work are natural parts of the global lifecycle. And because we care.



Availability and specifications are subject to change.



Printed with soy ink on FSC-certified paper.

Wausau Paper, an SCA company
1150 Industry Road, PO Box 189, Harrodsburg, KY 40330-0189
1-800-723-0001
sca.com/us · wausaupaper.com

©2013 Wausau Paper, an SCA company. All Rights Reserved.

BROCHURE-PDG-001/0916